

PS-RBP
PS-RDIS



**ParkAlert Rear Sensor System
with Buzzer or Display
User Manual**



**ECHOMASTER
PRO**



PS-RBP/PS-RDIS ParkAlert Rear Sensor System with Buzzer or Display

Introduction

Congratulations on purchasing EchoMaster PRO parking sensors. This ultrasonic detection system is designed to assist in the avoidance of obstacles while reversing.

Disclaimer:

EchoMaster® is strictly a driver assistance device, and should not be relied upon as a substitute for safe driving practices. Use common sense when parking and always follow recommended safe driving guidelines from your local, State and County Department of Motor Vehicles regarding parking procedures. To help prevent accidents, always use caution when parking, looking visually to ensure your path is clear. Keep speeds under three miles per hour. The owner shall not be entitled to recover from the Company, its successors or assignees, incidental and consequential damages, such as personal injury, loss of income, loss of time, loss of profits, loss of vehicle use or property damage. No employee, agent or representative of the Company of the Selling Retailer may modify, alter or extend this Warranty in any way. This Warranty gives you specific legal rights. You may also have other rights under this Warranty which may vary from state to state.

Note: Under no circumstances should you attempt to open the control box or any other component. Doing so will void all manufacturer's warranties.

This manual covers products:

PS-RBP-B	(ParkAlert Rear Sensor System with Buzzer - Gloss Black sensors)
PS-RBP-M	(ParkAlert Rear Sensor System with Buzzer - Matte Black sensors)
PS-RBP-S	(ParkAlert Rear Sensor System with Buzzer - Silver sensors)
PS-RBP-W	(ParkAlert Rear Sensor System with Buzzer - White sensors)
PS-RDIS-B	(ParkAlert Rear Sensor System with Display - Gloss Black sensors)
PS-RDIS-M	(ParkAlert Rear Sensor System with Display - Matte Black sensors)
PS-RDIS-S	(ParkAlert Rear Sensor System with Display - Silver sensors)
PS-RDIS-W	(ParkAlert Rear Sensor System with Display - White sensors)

Box Contents

- ▶ 4 Bumper Mount Sensors with 18" Pigtail
- ▶ 4 Black Rubber Seals
- ▶ 4 6° Sensor Sleeves
- ▶ 4 12° Sensor Sleeves
- ▶ Control Module
- ▶ Speaker with Volume Control
- ▶ Power Harness
- ▶ 22.5mm Hole Saw
- ▶ Accessory Pack
- ▶ Measuring Tape
- ▶ User Manual
- ▶ Warranty Card

Key Features

- ▶ Triangulation technology
- ▶ 2 or 4 sensor installation
- ▶ Low profile, paintable sensors
- ▶ Wide detection angle with minimal blind area
- ▶ OE sounding tone
- ▶ Dip switch settings for detection zones
- ▶ Self-diagnostic mode at startup
- ▶ Compatible with optional display (P/N: PA-DISPLAY)



PS-RBP/PS-RDIS ParkAlert Rear Sensor System with Buzzer or Display

Fitting Instructions

Recommended Tools for Installation

- ▶ High torque drill, use slow speed (approx 400 rpm)
- ▶ Grease Pencil and Center Punch for marking drill point
- ▶ 1/8" carbide tipped drill bit for starting pilot hole
- ▶ Hole Saw 22.5mm (Included)
- ▶ Pliers, Crimpers & Soldering Iron
- ▶ Multi-Meter
- ▶ Zinc Galvanizer or a rust inhibitor for metal (OPT P/N: EMZ)
- ▶ Safety goggles
- ▶ Angle Gauge Sleeve Selector (OPT P/N: SP1022)
- ▶ Measuring Tape

Optional Tools

- ▶ Panel tool (for situations requiring plastic, inner panels to be removed)
- ▶ Phillips head tip for drill
- ▶ Wire pulling tool (for routing wires)/ Fishing tool
- ▶ Semi-circular metal file (for smoothing hole edges when necessary)- DO NOT use fingers to test holes for burrs or smoothness. EDGES ARE SHARP!!!

Determining Sensor Position: Measure Twice, Cut Once!

Inspect behind the bumper in the approximate mounting area to check for any possible obstructions.

A proper installation will take into consideration two factors:

- (1) **Placement:** height and distance either side of bumper center.
- (2) **Angle:** accurate detection depends on the correct sensor angle.

The sensors need a 1" clearance space behind the bumper to be completely inserted. Some bumpers have an outside cover or fascia and a metal backing. You may have to drill through both layers to ensure you have enough clearance in order to fit the sensors. Other bumpers require some removal of foam backing.

CAUTION: Be careful of hot engine parts and/or sharp edges under bumper.

DO NOT INSTALL SENSORS ABOVE EXHAUST PIPE.
Doing so may cause false alerts.



PS-RBP/PS-RDIS ParkAlert Rear Sensor System with Buzzer or Display

Fitting Instructions - (continued)

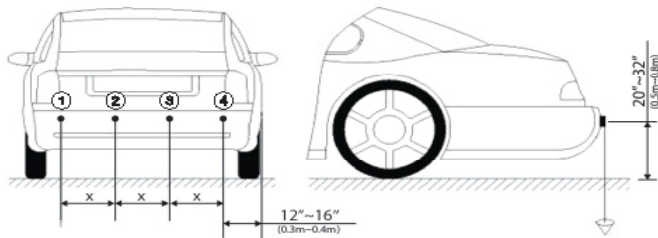

Sensor Install: Sensors must be installed in order 1-4 from left to right with control module harness entering trunk near sensor #4. If only using 2 sensors for the install, it is recommended to use sensors 2 and 3.

Choosing the Correct Angle Sleeve (Optional angle gauge: SP1022)

Vehicle is parked on flat and level ground and the parking brake is set. Place the Angle Gauge flat against the surface of the bumper. The swingarm will point to the correct measurement.

DO NOT CONTINUE TO NEXT STEP IF ARM FALLS BEYOND THE LAST LINE ON THE MARKER!

This means that the placement is too steep; re-evaluate placement and find a better area.

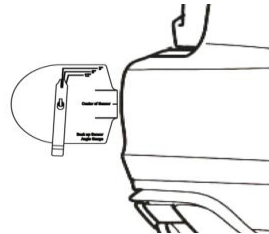

Drilling Holes and Installing Sensors

Warnings / Precautions: Please consult with us before installing on a vehicle with any rear or front mounted external appliances, like spare tires, bike racks, brush guards, etc, which may interfere with the system's detection and cause false detection.

(1) The Sensor Holes

Using the provided Hole Saw, cut the sensor holes. Always wear approved safety glasses when drilling and use caution. If drilling a metal bumper, coat edges of holes with Zinc Galvanizer, a rust inhibitor.

(2) Mount Sensor

Ensure correct angle sleeve is being used. Insert sensor with the "up" marking facing up.

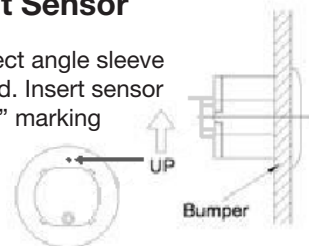

PS-RBP/PS-RDIS ParkAlert Rear Sensor System with Buzzer or Display

Fitting Instructions - (continued)

Connecting the Power Harness

To find reverse power, remove tail light and examine where and what wires plug into the reverse bulb. Locate and verify with a volt meter. The wire carries 12 volts when in reverse and 0 volts when out of reverse.



NOTE: It is recommended to solder all connections.

NEVER USE A TEST LIGHT TO PROBE WIRES

Once the reverse wires are found, connect the red wire from the power harness to it. Connect the black ground wire from the unit's wiring harness to the vehicle's ground wire. Route cable to control module and plug in.



Running Sensors to Control Module

Many vehicles will have factory grommets to allow routing of wires from the outside to the inside of the vehicle. If you are drilling a hole through a metal body panel to route your sensor wires into the passenger compartment, determine where the sensor wires will enter into the passenger compartment and route to control module. Control module must be on right (passenger side) of vehicle.

Mounting Speaker

The speaker has 3 adjustment positions: Hi, Low, and Off. You usually want to keep the speaker on the same side of the vehicle as the control module for ease. Clean the mounting area with the supplied alcohol pad, affix adhesive to the back of the speaker, and firmly press the speaker into place. Route speaker cable to control module and plug into power harness.

If using display, please refer to PA-DISPLAY user manual for mounting instructions.



PS-RBP/PS-RDIS ParkAlert Rear Sensor System with Buzzer or Display

Fitting Instructions - (continued)

Choosing Correct Dip Switch Configuration

For most vehicles, all switches DOWN will work fine. However, should you need to make changes, please see below.

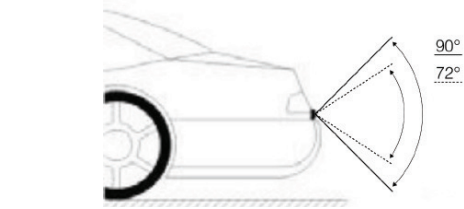
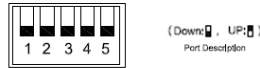

Switch	Vertical Angle
1	Down: Original Coverage Range Up: Reduce 20% Coverage Range

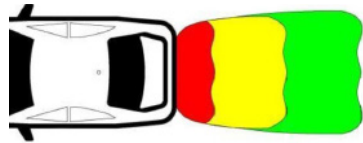

Switch	Zone Range
2 & 3	Down & Down: Default Zone Range Down & Up: Add 20in to Range Up & Down: Add 28in to Range

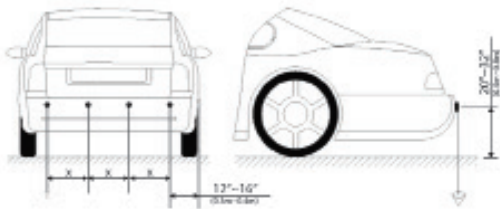

Switch	Sensor Spacing (in)
4 & 5	Down & Down: 16-16-16 Down & Up: 14-20-14 Up & Down: 12-24-12 Up & Up: 8-32-8

Mounting Control Module

You will want to mount the control module behind one of the vehicle's body panels. Clean a suitable location using the provided alcohol swab. Plug in all the wires, adjust dip switches, then peel backing of Velcro liner to mount. Finish by securing any loose and/or excess wiring. Before reassembling any panels that might have been removed from the vehicle, test the system.



PS-RBP/PS-RDIS ParkAlert Rear Sensor System with Buzzer or Display

Sensor Assembly

Step 1

To take the sleeve off of the sensors lift up on 1 clip and push the sensor out with your thumb.



Step 2

Slide the sensor angle sleeves onto the sensors. The embossed angle measurement should be on the same side as the clip.



Step 3

Ensure that the arrow molded into the back of the sensor points to the line on the angle sleeve.





PS-RBP/PS-RDIS ParkAlert Rear Sensor System with Buzzer or Display

Sensor Painting

Step 1

Remove the silicon gasket and disconnect cable before painting the sensors. Certain colors may require a thin coat of primer.



Step 2

Paint the front of the sensors and the angle sleeve. Avoid getting excessive paint on the back of the sensors. Paint thickness should not exceed 1mm or sensors may not function properly.

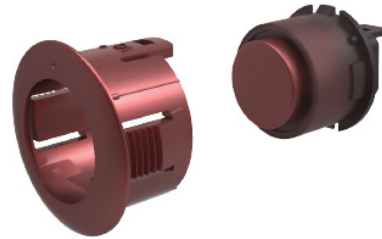

Note: Gasket is only removable on paintable sensors.

Step 3

After the paint has fully dried, reassemble the sensors as shown below.



PS-RBP/PS-RDIS ParkAlert Rear Sensor System with Buzzer or Display

Wiring Diagram

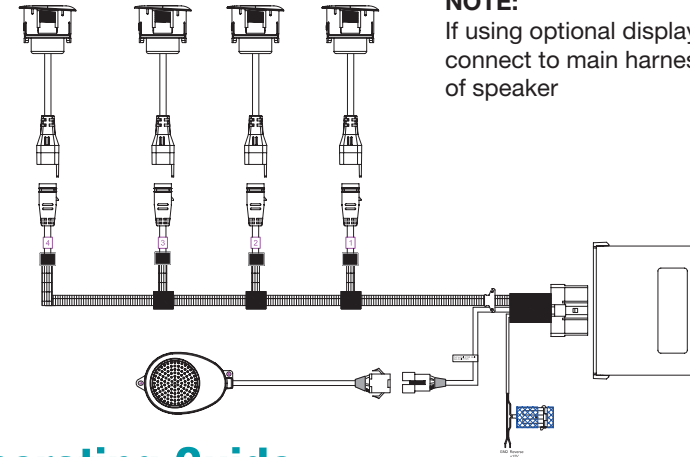

NOTE:
If using optional display (PA-DISPLAY) connect to main harness in place of speaker

Operating Guide

System will become engaged when vehicle is put into reverse. The system should beep one time when reverse is activated to notify the driver that it is on and working. Once an object is detected within the range, the system will alert the driver via audible tone or visual indicator (if using the display).

Distance	Awareness	Display/Alarm Sound
<12" / <0.3m	Danger	-P- (STOP)/Beep (Biiiiiiiiiiiiiiiiii)
12" – 19" / 0.3-0.5m	Danger	Inches/Bi. Bi
19" – 27" / 0.5-0.7m	Caution	Inches/Bi.. Bi
27" – 35" / 0.7-0.9m	Caution	Inches/Bi... Bi
35" – 47" / 0.9-1.2m	Safety	Inches/Bi.... Bi
47" – 67" / 1.2-1.7m	Safety	Inches/Bi..... Bi
>67" / >1.7m	Outside	Inches (up to 98")/None

NOTE - The chart reflects the default zone range. Performance may be affected by the following: Heavy rain, loose gravel/bumpy road, steep slopes, flat/smooth surfaces. Keep sensor surface free of snow, ice, mud, etc.



PS-RBP/PS-RDIS ParkAlert Rear Sensor System with Buzzer or Display

Dimensions (mm/in)

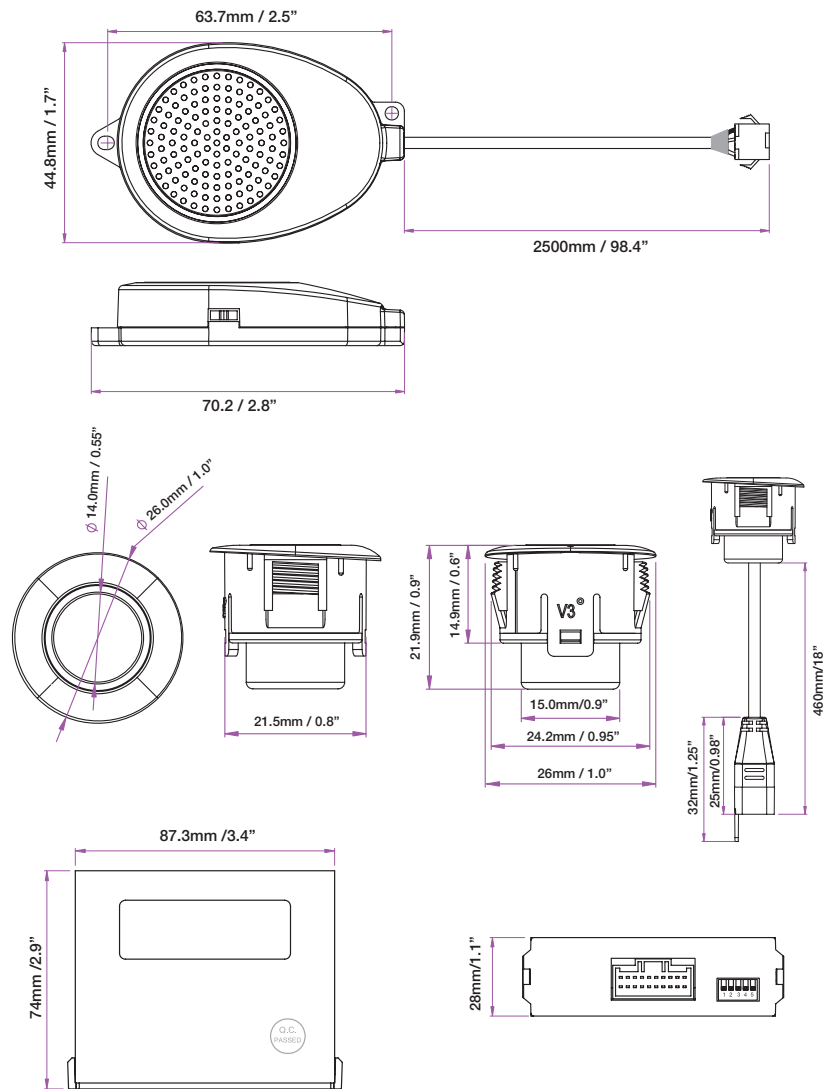

PS-RBP/PS-RDIS ParkAlert Rear Sensor System with Buzzer or Display

Troubleshooting

PROBLEM	REASON	SOLUTION
System doesn't react when reverse is engaged	System is not powered up or wrong connection of power cable	Check the power and ground connections
	Invalid connection between speaker/display and control module	Check the connection between speaker/display and control module
After activation, system continuously beeps for 3 seconds	Invalid connection between sensors and control module	Check the connection between sensors and control module
	All sensors are defective	Replace the defective sensors
False alarms	Sensors pointing down	Change angle sleeve
	Sensors rotated	Note 'UP' marking on sensor and adjust accordingly

Specifications

PS-RBP-B/M/W/S - PS-RDIS-B/M/W/S	
Operating Voltage Range	10.5 - 16V DC
Rated Voltage	12V DC
Rated Current	400mA
Operating Temperature	-20C - +70C
Waterproof Grade (Sensors & Module)	IP67 - Module: IP40
Detection Range	0-1.7m; 0-8.2ft
Harness Length	8 feet
Hole Saw	22.5mm
Angle Sleeves	6 degrees and 12 degrees



15500 Lightwave Drive, Suite 202, Clearwater, Florida 33760
Woolmer Way, Bordon, Hampshire, United Kingdom

email - support@aampglobal.com (US)
tel - 1-800-477-2267 (East Coast) - 1-888-883-2790 (West Coast)

email - technical.eu@aampglobal.com (Europe)



EchoMaster is a Power Brand of AAMP Global.
EchoMaster.com